



Technical Specification

Model	AV 14DA	AV 24DA	AV 34DA
Display	4 Digit, Single Display		
Size(HXWXD)	96 X 96 X 43 mm	72 X 72 X 36 mm	48 X 96 X 26 mm
Panel Cutout	92 X 92 mm	68 X 68 mm	46 X 92 mm
Input	-75 to 75mV DC		
Current Range	-999 TO 9999 Ampere		
Power Supply	100 to 270V AC/DC, 50/60 Hz, Approx 2VA		
Protection Level (As per request)	IP-65(Front side) AS per IS/IEC 60529:2001		
Operating Temperature	0 °C To 55 °C	Relative Humidity	Up to 95% RH Non Condensing

Error Display

When an error has occurred the display indicates error codes as given below.

ERROR	MEANING
SHEr	Shunt error or shunt connection is open
Over	Shunt input signal is excess more then 75mV DC

Shunt selection

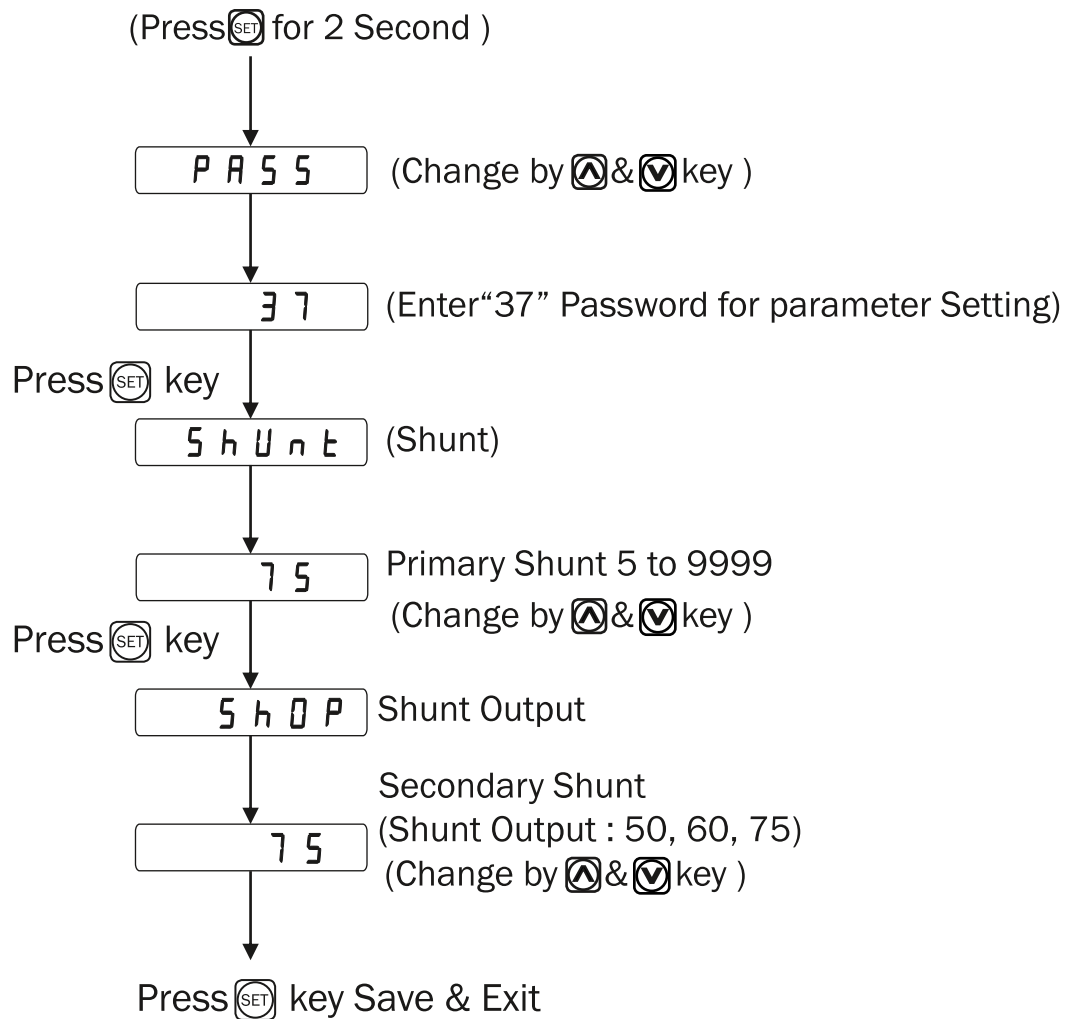

Connection Diagram

AV-14DA

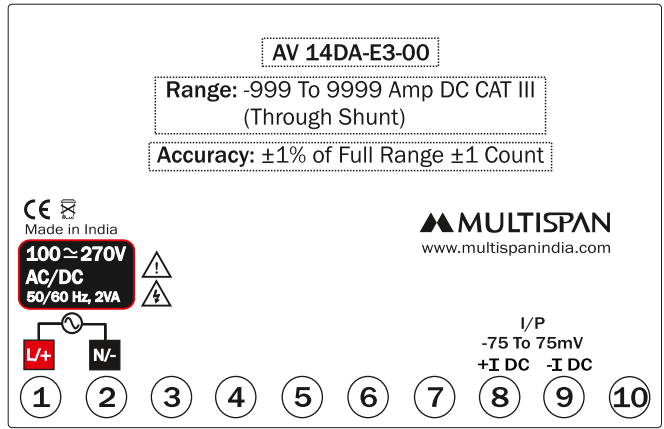

AV-24DA

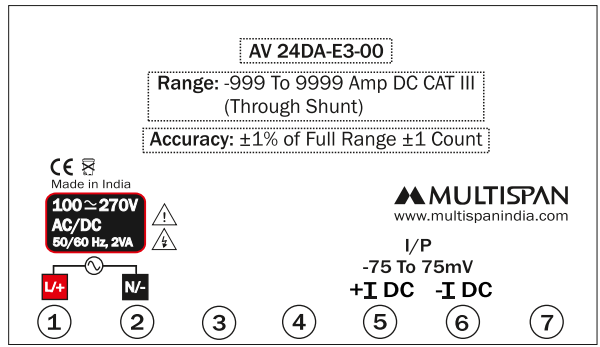

AV-34DA

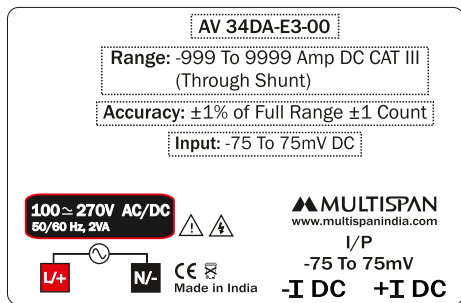

Safety Precautions

All safety related codifications, symbols and instructions that appear in this operating manual or on the equipment must be strictly followed to ensure the safety of the operating personnel as well as the instrument.

If all the equipment is not handled in a manner specified by the manufacturer, it might impair the protection provided by the equipment .

=> Read complete instructions prior to installation and operation of the unit.

 **WARNING** : Risk of electric shock.

Warning Guidelines

- 1) To prevent the risk of electric shock power supply to the equipment must be kept OFF while doing the wiring arrangement. Do not touch the terminals while power is being supplied.
- 2) To reduce electro magnetic interference, use wire with adequate rating and twists of the same of equal size shall be made with shortest connection.
- 3) Cable used for connection to power source, must have a cross section of 1mm^2 or greater. These wires should have insulations capacity made of at least 1.5kV.
- 4) A better anti-noise effect can be expected by using standard power supply cable for the instrument.

Installation Guidelines

- 1) This equipment, being built-in-type, normally becomes a part of main control panel and such in case the terminals do not remain accessible to the end user after installation and internal wiring.
- 2) Do not allow pieces of metal, wire clippings, or fine metallic fillings from installation to enter the product or else it may lead to a safety hazard that may in turn endanger life or cause electrical shock to the operator.
- 3) Circuit breaker or mains switch must be installed between power source and supply terminal to facilitate power 'ON' or 'OFF' function. However this mains switch or circuit breaker must be installed at convenient place normally accessible to the operator.
- 4) Use and store the instrument within the specified ambient temperature and humidity ranges as mentioned in this manual.

Mechanical Installation

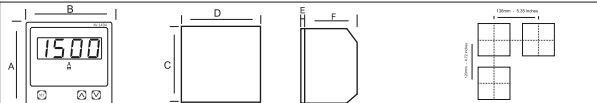
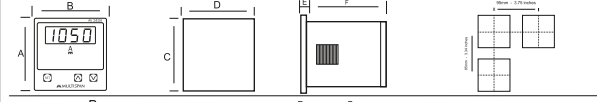
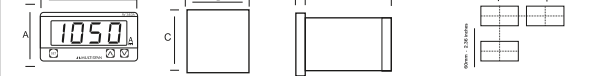
	<table border="1"> <thead> <tr> <th>MODEL</th> <th>A</th> <th>B</th> <th>C</th> <th>D</th> <th>E</th> <th>F</th> </tr> </thead> <tbody> <tr> <td>DIMENSIONS</td> <td>96mm</td> <td>96mm</td> <td>92mm</td> <td>92mm</td> <td>3mm</td> <td>43mm</td> </tr> </tbody> </table>	MODEL	A	B	C	D	E	F	DIMENSIONS	96mm	96mm	92mm	92mm	3mm	43mm
MODEL	A	B	C	D	E	F									
DIMENSIONS	96mm	96mm	92mm	92mm	3mm	43mm									
	<table border="1"> <thead> <tr> <th>MODEL</th> <th>A</th> <th>B</th> <th>C</th> <th>D</th> <th>E</th> <th>F</th> </tr> </thead> <tbody> <tr> <td>DIMENSIONS</td> <td>72mm</td> <td>72mm</td> <td>68mm</td> <td>68mm</td> <td>3mm</td> <td>36mm</td> </tr> </tbody> </table>	MODEL	A	B	C	D	E	F	DIMENSIONS	72mm	72mm	68mm	68mm	3mm	36mm
MODEL	A	B	C	D	E	F									
DIMENSIONS	72mm	72mm	68mm	68mm	3mm	36mm									
	<table border="1"> <thead> <tr> <th>MODEL</th> <th>A</th> <th>B</th> <th>C</th> <th>D</th> <th>E</th> <th>F</th> </tr> </thead> <tbody> <tr> <td>DIMENSIONS</td> <td>48mm</td> <td>96mm</td> <td>46mm</td> <td>92mm</td> <td>4.5mm</td> <td>26mm</td> </tr> </tbody> </table>	MODEL	A	B	C	D	E	F	DIMENSIONS	48mm	96mm	46mm	92mm	4.5mm	26mm
MODEL	A	B	C	D	E	F									
DIMENSIONS	48mm	96mm	46mm	92mm	4.5mm	26mm									

- 1) Prepare the panel cutout with proper dimensions as show above.
- 2) Fit the unit into the panel with the help of clamp given.
- 3) The equipment in its installed state must not come in close proximity to any heating source, caustic vapors, oils steam, or other unwanted process by products.
- 4) Use the specified size of crimp terminal (M3.5 screws) to wire the terminal block. Tightening the screws on the terminal block using the tightening torque of the range of 1.2 N.m.
- 5) Do not connect anything to unused terminals.

Maintenance

- 1) The equipment should be cleaned regularly to avoid blockage of ventilating parts.
- 2) Clean the equipment with a clean soft cloth. Do not use isopropyl alcohol or any other cleaning agent.
- 3) Fusible resistor must not be replaced by operator.

Product improvement and upgrade is a constant procedure. So for more updated operating information and support, Please contact our helpline : +91-9081078683/9081078681 or Email at Service@multispanindia.com Ver: 2203